

Glimpse the future.

With clamping and drive technology from Ortlieb.



Company strategy with perspective.





Dipl.-Wirt.-Ing. (FH) Dirk Laubengeiger, Managing Director

Innovation from tradition.

Ortlieb sees itself as a company whose wealth of groundbreaking product innovations has allowed it to stand out from the rest throughout its history. We believe it is our duty to follow this precedent, both now and in the future – which is why, for some time now, we have been applying our company philosophy to our surroundings too. For example, 2017 has seen us complete the construction of and move into one of Baden-Württemberg's most innovative company premises, which meets the very highest standards of functionality, energy efficiency and architectural design. Equipping the large production facility with state-of-the-art machine tools is a clear declaration of loyalty to Germany as our place of manufacture. As pioneers in our industry who always put the customer first, we promise our great many clients that we will set new benchmarks in quality, flexibility and productivity, and make processing times quicker than ever. The focus of our business activities in clamping and drive technology has always been on forming close relationships with our customers – and it will always be.

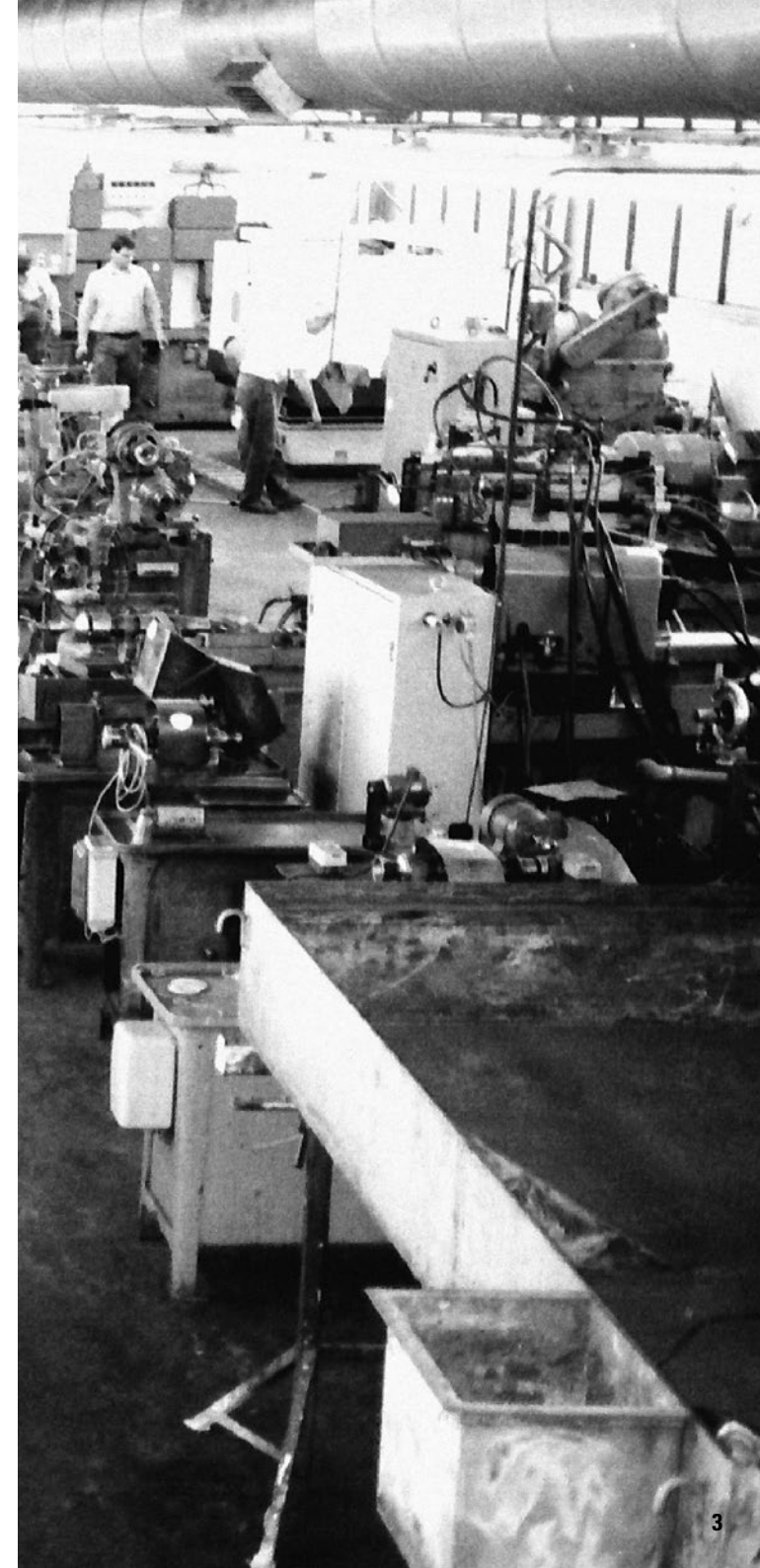

Three product lines – one promise: Quality.

Workpiece clamping

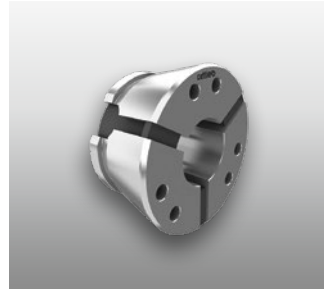
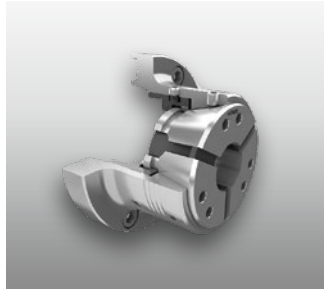
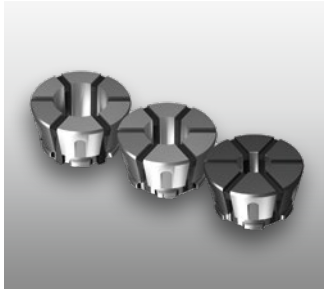

Tool clamping

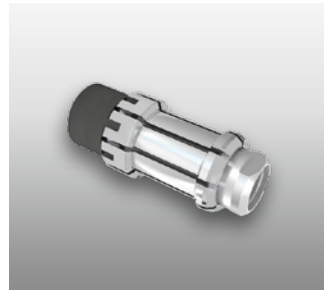

Drive technology

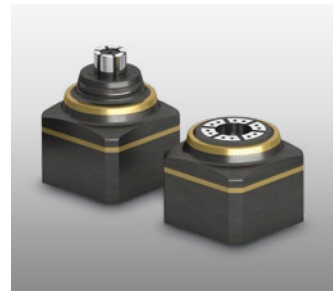

Persistent drivers of innovation. Since 1911.

For over a hundred years, Ortlieb has been a customer-centric partner for those seeking precise yet cost-effective tool and workpiece clamping solutions. A new tradition in mechatronic drive technology was established 20 years ago too. We are not

only responding to market expectations but also calling upon tradition to assume the role of a leading driver of innovation at an international level.



Workpiece clamping – made individual with considerable variety. For all applications. On any machine.

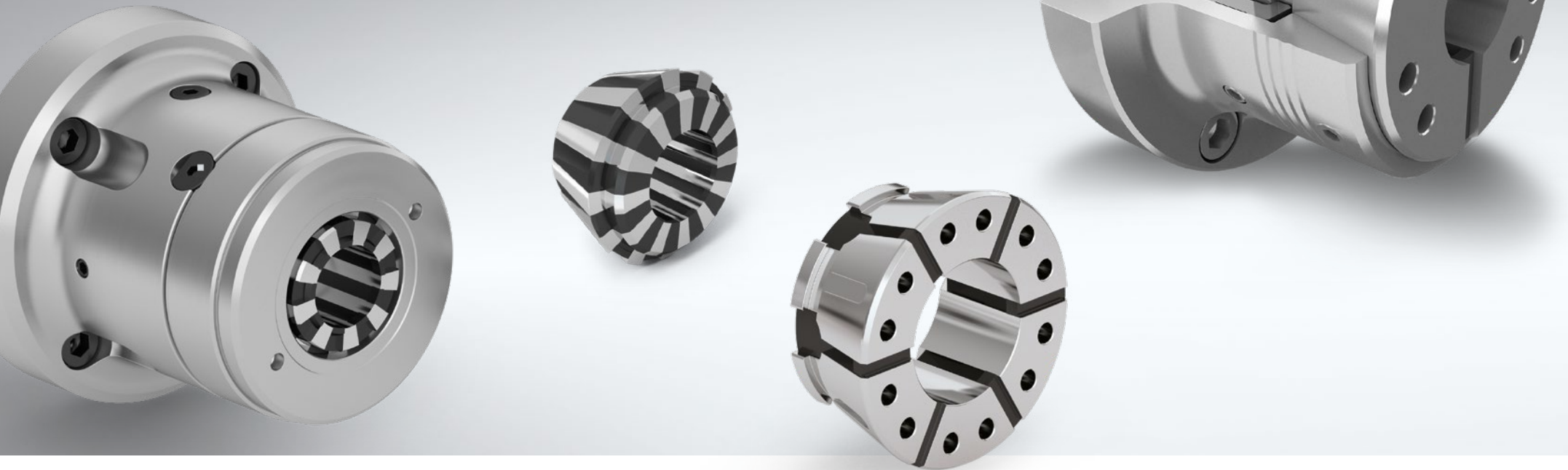

Perfect for use in lathes, mills and rotary transfer machines.

Compact and lightweight yet also robust, Ortlieb products for workpiece clamping make it possible to perform just about all "individual" machining steps. Many of our products help minimise set-up times and downtimes. The electric drive technology they employ makes them not only more

energy efficient than hydraulic systems, but also already ideally placed to cater to the demands of the digitalised industry of tomorrow. Custom-made clamping devices for workpiece automation complete our product portfolio perfectly.

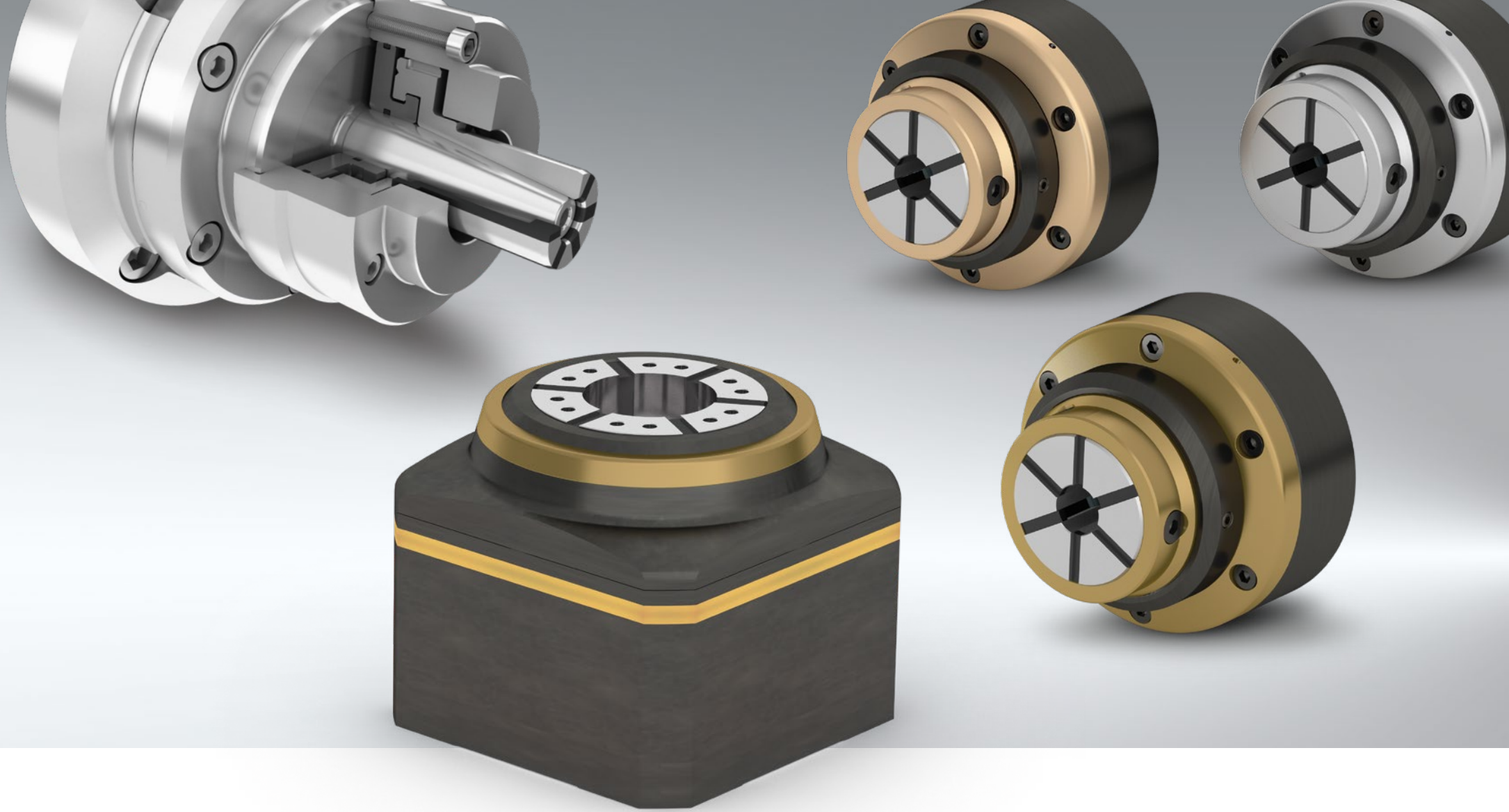

Tool clamping perfection.

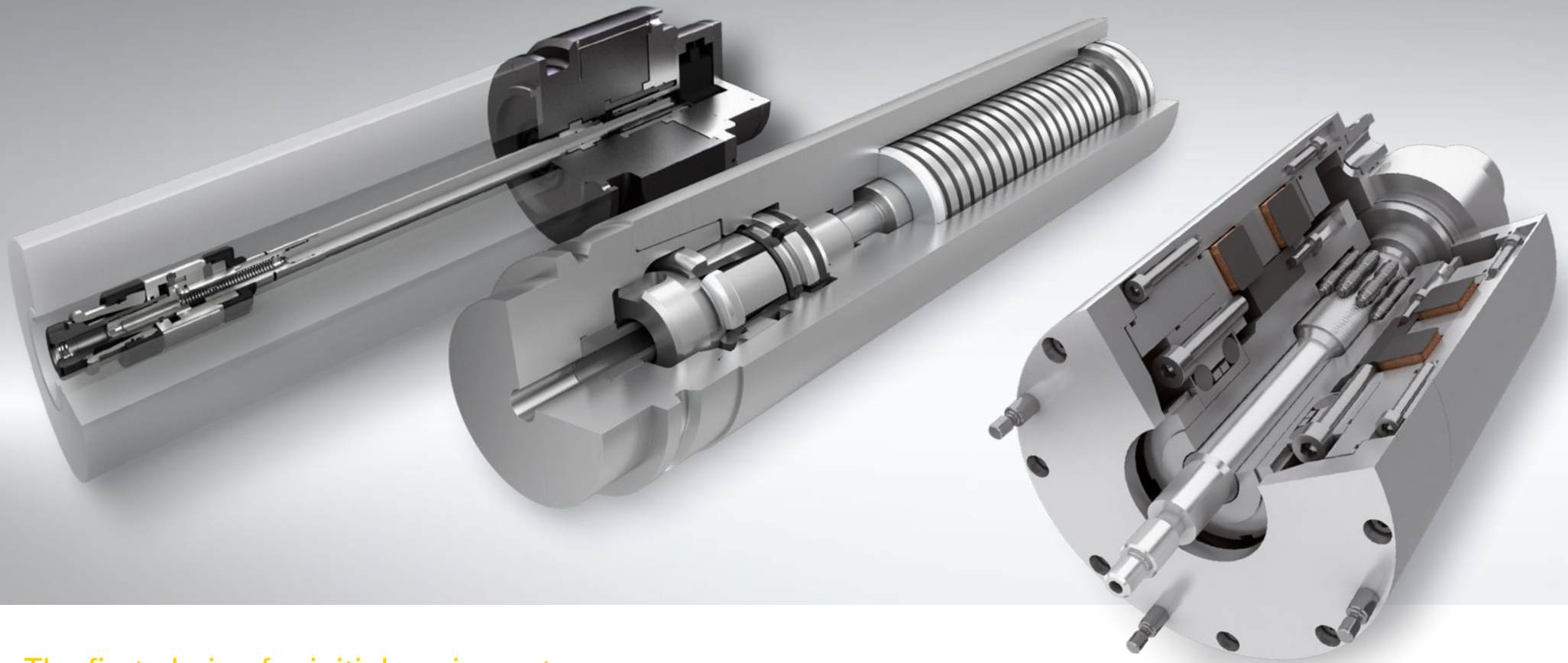

The first choice for initial equipment.

Ortlieb tool clamping sets and systems are held in high regard by renowned machine tool manufacturers, who have been using them in their machinery for decades. Our product range comprises steep taper and hollow shank taper clamping sets for virtually maintenance-free

operation, even with ceramic slide rings. Complete spring compressors, mechanical intensifying and locking units and electromechanical release units attest to our holistic approach. Numerous custom solutions also provide proof of our flexibility and capacity for innovation.



Drive systems with maximum power density.



Ultra-compact for space-restricted applications and extremely precise.

The high control performance of Ortlieb electrically powered drive systems enables them to be used in applications with very short cycle times in an axial force range of 5 to 300 kN. This means our products frequently offer a clean and economical alternative to hydraulic

systems. Thanks to the slim design and extremely high power density of our SERAC® electric cylinders, in many situations it is possible to completely replace hydraulic cylinders without spending considerable time and money on construction work.



Unique attributes with significant effects.

- Precise control of force and position
- Highly dynamic
- Low noise generation
- Save as much as 80% energy and reduce cycle times by up to 50% in comparison with hydraulic solutions
- No leaks and no need to dispose of hydraulic oil

Innovations with profound impact.

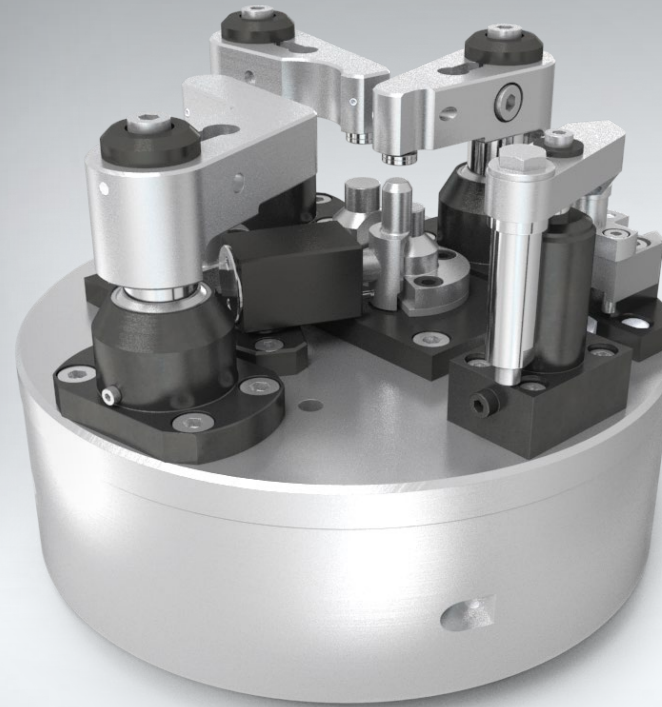

Inventive genius and expertise.

Thanks to its distinguished tradition, Ortlieb can lay claim to be one of the world's leading drivers of innovation in its industry. This claim is based on the combination of Swabian inventive genius, over 100 years' experience and dependable, long-established values. The history of our company has been

shaped by a number of groundbreaking product innovations that were all born from the desire to make our customers' work processes easier – through increased dynamics, greater flexibility, easier operation or optimisation according to economic and eco-friendly assessment criteria.

VarioLine – workpiece clamping for non-rotating applications.

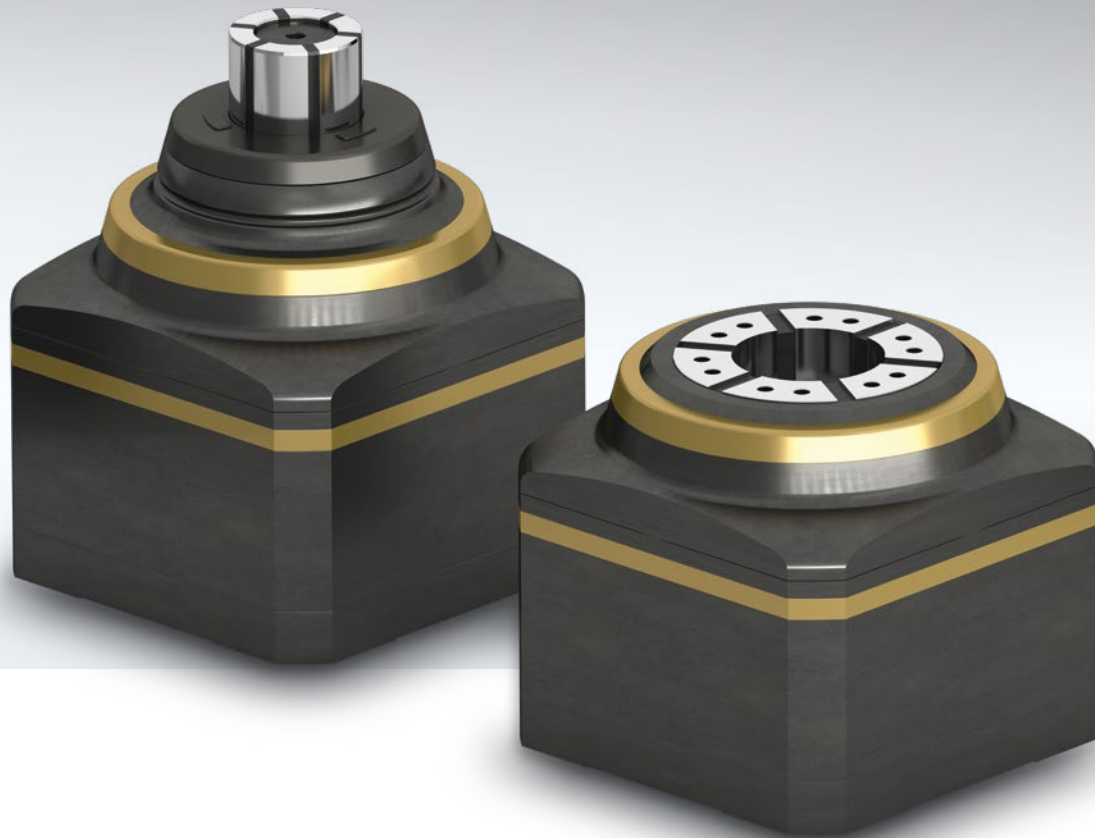

Innovative

When permanently installed in the machine tool, the clamping force, clamping force control, status and the stop can be monitored electronically. VarioLine – perfect networking in terms of Industry 4.0.



Efficient

Targeted monitoring and control lead to efficient use of the machine. Perfect for unattended operation and series manufacture. Identify and enhance potential.



Cost-efficient

Electronic drive technology now also incorporated in clamping technology. Save money compared to energy-intensive monitoring using compressed air.



Flexible

For mobile or stationary use, or in the variable conversion from internal to external clamping. A practical additional function of the VarioLine clamping systems for expanding the number of potential applications.

Custom solutions with maximum individuality.

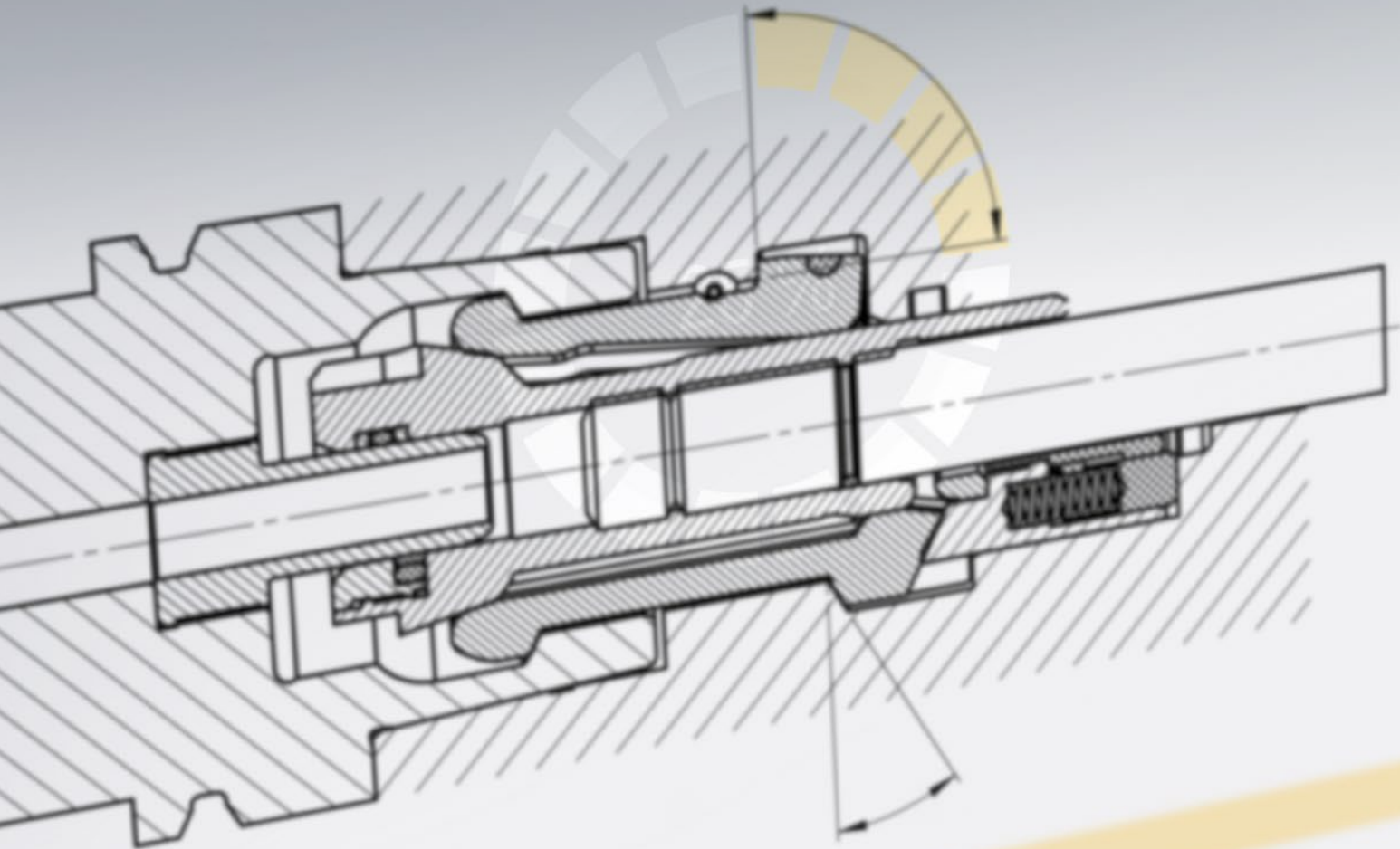

We develop solutions – for you and with you.

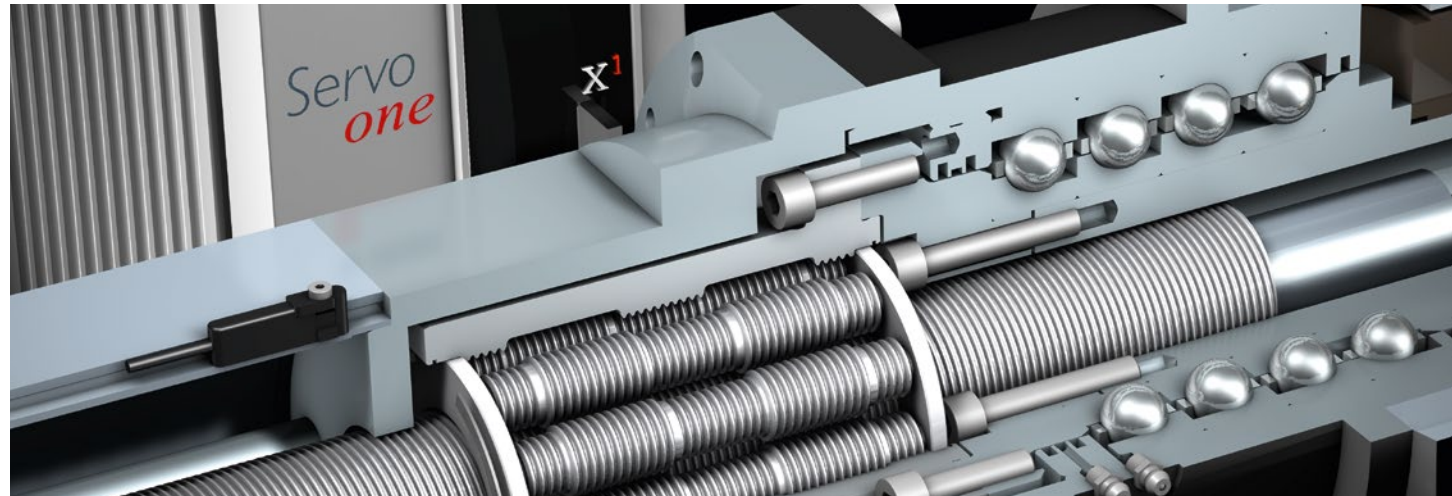

At Ortlieb you benefit from the synergy effects of our integrated organisation and manufacturing structures. In terms of practical advantages, this brings you more innovation, greater dynamics and maximum flexibility. This means that in addition to offering a wide range of standard products, we can also create and deliver custom solutions in next to no time.

In this process, you benefit from professional advice and our employees' many years of experience in the market and in the industry, right from the very beginning. Our experts work together with you to develop the best possible solutions, tailored precisely to your exact requirements.

“Our expertise means we can offer our customer quick yet individual solutions.”



Technical competence

We have a well-balanced mix of young, dynamic employees and experienced staff who have been with the company for a long time.



Flexibility

Our streamlined structures and efficient teams allow us to offer our customers maximum flexibility – even when developing custom solutions. Together we will find a solution.



Quality

We develop premium-quality products with performance you can rely on. This is why Ortlieb makes most of its products in-house.



Speed

We guarantee fast processing and reaction times. Our decades of experience enables us to create not only standard but also custom solutions in next to no time.

Comprehensive expert service.

We are always there for you.

The tasks and challenges our customers face are becoming ever more complex, which means that we as a manufacturer need to support them with a fast, flexible, efficient and extensive range of services. Our advisers, engineers and developers are always there for you to provide enthusiastic assistance with whatever you need.



Advice

We offer personalised, tailored advice at your company's premises, as we believe this is the best way to understand your needs and develop the perfect solutions for you.

Additional service for drive technology.



Hire purchase

You can hire our standard products to test risk-free for up to four weeks. If you decide to make a purchase, we will deem the rental costs to be part payment.



Controller tuning

Once you have reached the limit of the standard settings and need assistance, controller tuning can be carried out by our experts on your premises.



Commissioning





















The settings of your Ortlieb product are parametrised and optimised at your premises, with a view to enhancing efficiency.



Industry experience combined with knowledge of the demands of tomorrow.

From automotive to wind power.

Industry expertise

 Automotive industry	 Railway engineering	 Machine tools	 Steel industry	 Aviation and aerospace	 Custom machine and system construction	 Offshore
 Measurement technology	 Testing technology	 Medicine	 Plastics engineering	 Packing industry	 Textiles industry	 Agricultural and construction machinery
 Wind power	 Building services engineering	 Solar industry	 Paper industry	 Food industry	 Electronics industry	 Power plant technology



Both electric drive systems and clamping systems from Ortlieb are playing a pivotal role in advancing civilisation across almost all industries in numerous countries. Ortlieb electric drive systems, for example, are being used in space exploration, where the extremely precise positioning of cutting-edge telescopes under load has enabled new scientific findings to be made.

Ortlieb Präzisionssysteme GmbH & Co. KG

Jurastraße 11 · 73119 Zell unter Aichelberg, Germany

Telephone +49 (0) 7164-79701-0 · Fax +49 (0) 7164-79701-51

www.ortlieb.net · info@ortlieb.net

We look forward to hearing from you.
Clamping and drive technology from Ortlieb.

